

INSTRUCTIONS FOR INSTALLATION

Bobrick Cubicle Collection B-543 Toilet Tissue Dispenser

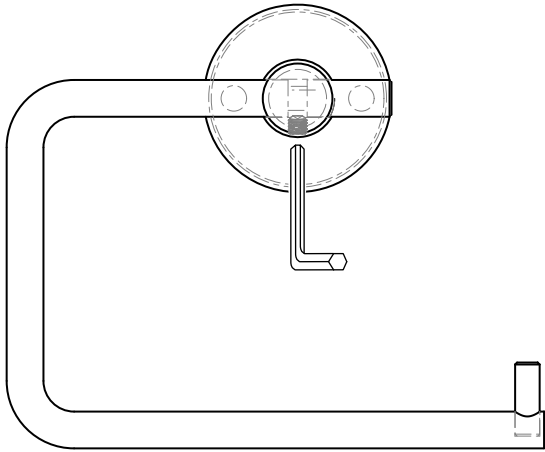

1. Loosen setscrew

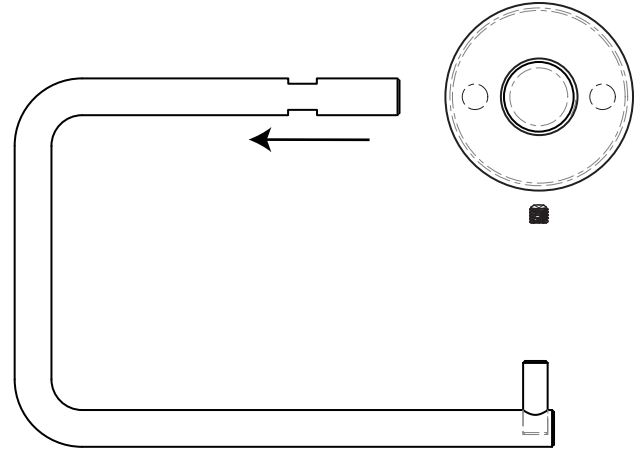

2. Remove bar

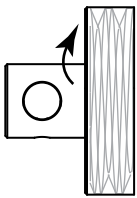

3. Unscrew escutcheon

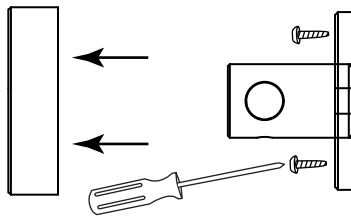

4. Insert mounting screws

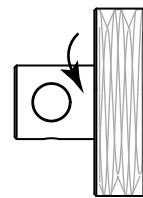

5. Replace escutcheon

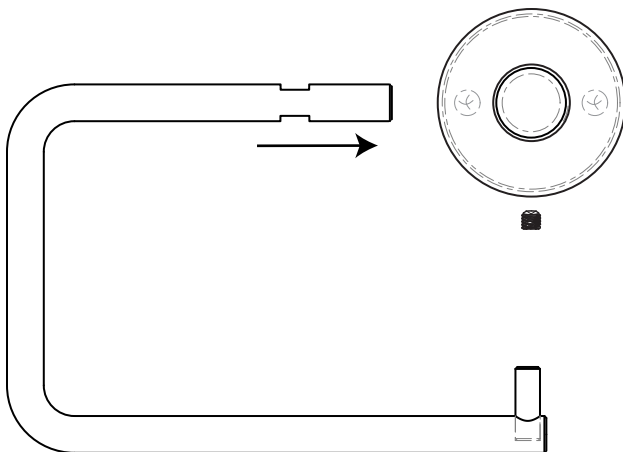

6. Replace bar, align set-notch

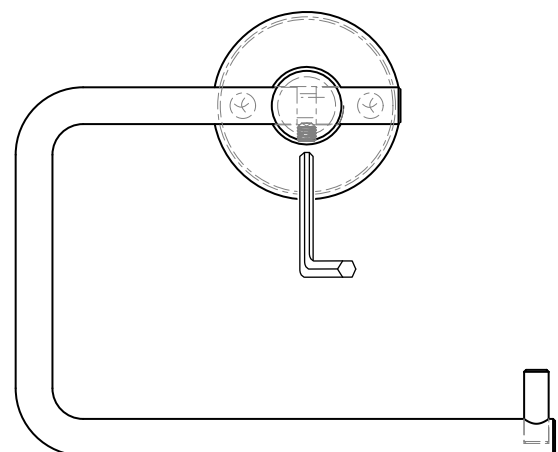

7. Replace setscrew

