



INTELLIGENT FACILITY SOLUTIONS
Electric Works, 3 Concourse Way
Sheffield, S1 2BJ, United Kingdom
Phone UK: +44 (0) 114 354 0047
Phone Eire: +353 190 36387
sales@ihdryers.co.uk
<https://www.intelligenthanddryers.com/>

SENSOR OPERATED

D- Flow



DF01W
white finish



DF01G
satin finish



DF01B
black finish

General description

- The D-Flow 240V is a fast, energy efficient, ecologic, hygienic & stylish hand dryer.
- “Hands in” model it has 2 pairs of IR sensors on both sides of the upper covers for instant hand detection
- Maximum air speed 410 Km/h.
- Dries hands in only 8 / 15 seconds.
- Motor power adjustable, allowing electricity consumption to be regulated. (Between 420 and 1.100W).
- 30 seconds safety timer.
- Lowest noise level in its category. (62 dBA in ECO mode).
- Suitable for medium and high traffic facilities.
- Easy maintenance.

Components & materials

- **DF01W:** ABS cover, white finish.
- **DF01G:** ABS cover, satin finish.
- **DF01B:** ABS cover, black finish.
- High speed class F universal brush motor, adjustable from 19000 to 30000 rpm.
- Minimum waved wire NiCr heating element of 400W, mounted on a mica frame that incorporates a self-resetable thermal cut-off which disconnect the whole appliance. The heating element can be disconnected by means of an ON/OFF switch.
- Biocote® antimicrobial and antibacterial protection technology based on silver ions. These ions inhibit the reproduction of micro-organisms in the product throughout its lifetime.
- Cartridge that holds an HEPA filter medium that filters suspended solid particles (pollen, dust mites, cigarette smoke, etc.), notably improving the air quality. Furthermore, this cartridge also contains and activated carbon filtering medium that neutralizes odours and absorbs fumes and gases, helping avoid bad odours.
- Base plate made in plastic PA6V0.
- Inner tank to collect the water. It is removable and it has an external valve for easy emptying.
- Optionally, and by means of a kit for the connection to the waste pipe, code KITDESM14A, the dualflow® Plus can be connected directly to the waste pipe.
- LED front light for fast diagnosis of the dryer (green - machine running, blue - full tank, red - check engine).
- Optical and acoustic warning full tank.
- Odor neutralizer (optional).

Technical Specifications

Voltage	220- 240 V
Frequency	50/60 Hz
Electrical Isolation	Class I
Total power	420 – 1,500 W
Consumption	3.2 – 6.4 A
Motor power	420 – 1,100 W
Rpm	19,000 – 30,000
Heating element power	0 or 400 W (ON/OFF)
Dimensions	665x320x228 mm
Weight	8.3 Kg
Cover thickness	3 mm
Drying time	8-15 sec
Effective airflow	94-165m ³ /h –1,570-2,750 l/min
Air velocity	234 – 410 Km/h
Air temperature (10 cm distance/21°C)	40 °C
Sound pressure ^(*) (at 2m)	62 – 72 dBA
Protection rating	IPX4

(*) According to UNE EN ISO 11201:2010 V2 standard.

Dimensions

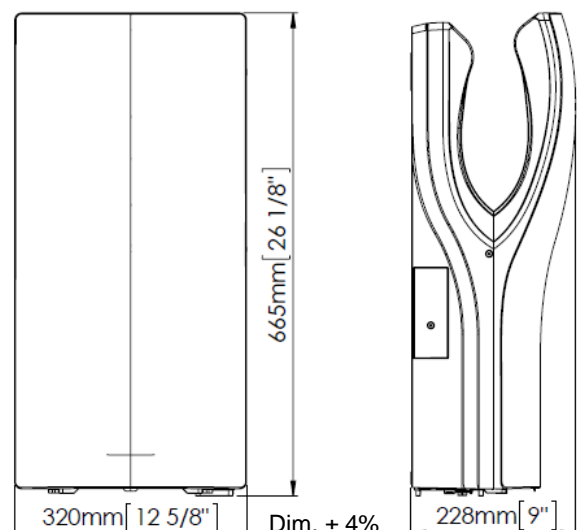

Operation

Place the hands between the air outflow valves, inside the hand dryer. The dryer will start automatically, and go on with no interruption as long as the hands are kept in the detection range of the sensor. Move the hands vertically in order to dry them completely. The appliance will stop 2 seconds after the hands are removed from the airflow.

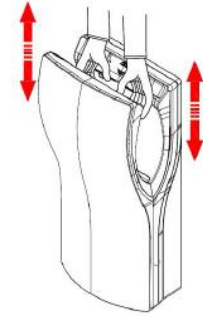

Mounting

Recommended heights distance from the floor

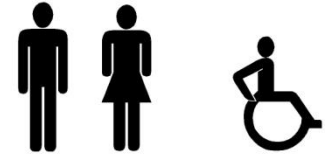
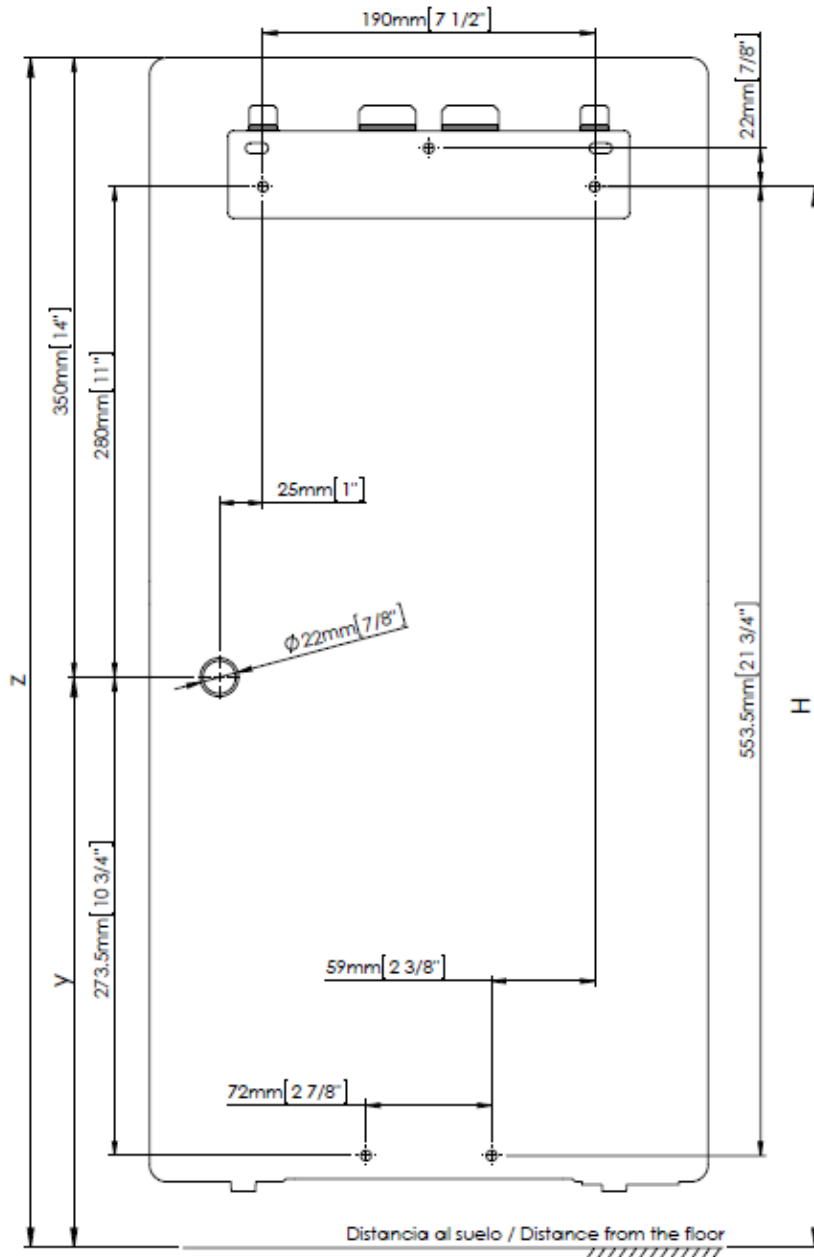

$Z =$	92 cm (36 1/4")	87 cm (34 1/4")
$H =$	85 cm (33 1/2")	80 cm (31 1/2")
$Y =$	57 cm (22 1/2")	52 cm (20 1/2")

Connection to the waste pipe

1

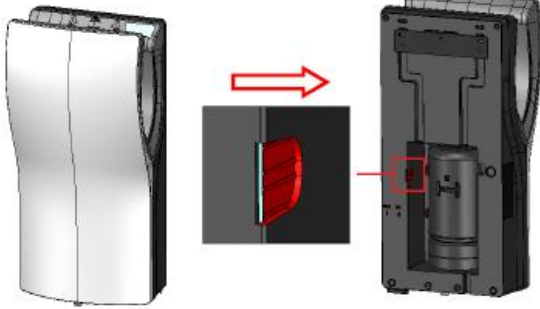

Break the flap on the rear side of the hand dryer base. Use a screwdriver and a hammer to do it more easily

2

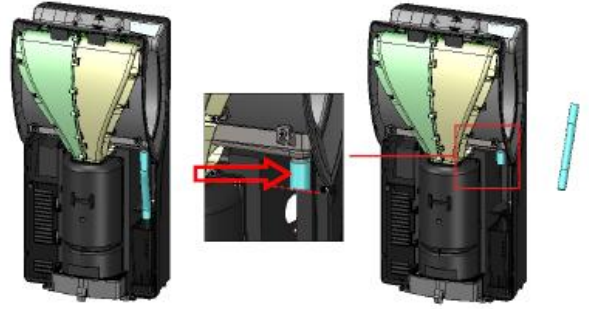

Disassemble the frontal cover and cut the original drain tube skim to the plastic union using a cutter

3



Introduce one end of the new tube through the new hole in the backside and fix the other side over the remaining part of the cut old tube using the provided flange

4

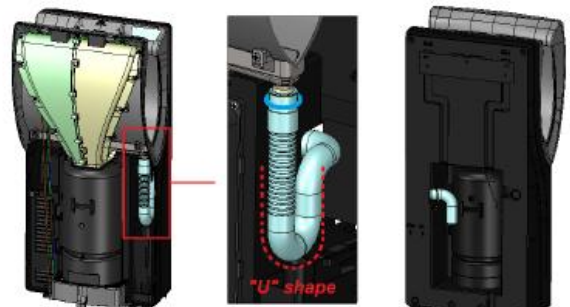

Confirm that the new tube maintains a "U" shape once assembled and connect the backside part of the tube to the waste pipe. Finally, assemble the frontal cover.

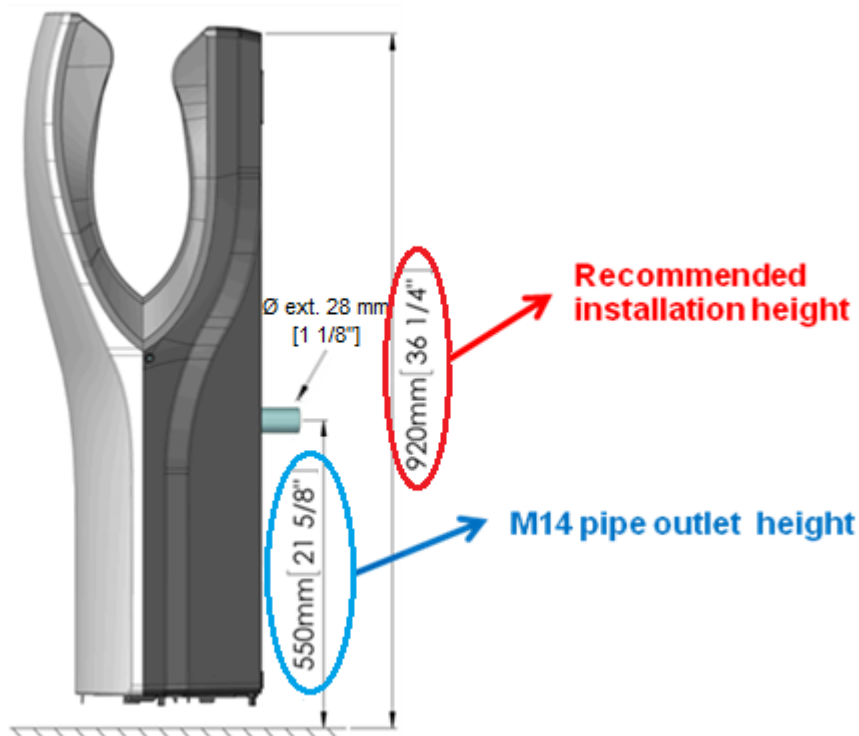

Certificates & Qualifications



Intelligent Facility Solutions reserves the right to make changes and/or modifications to the products and their specifications without prior notice.

